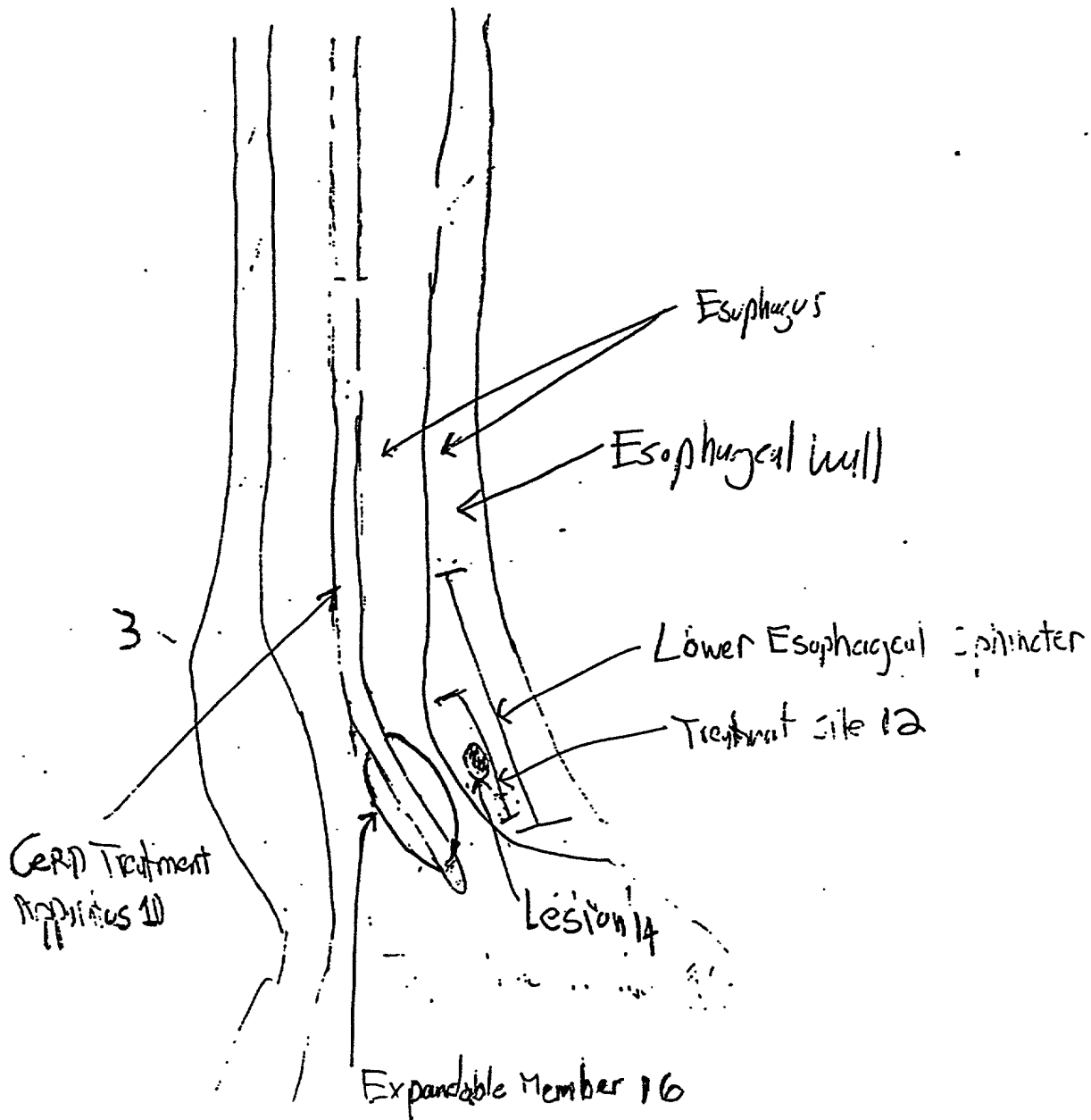



FIG. 1



200250-42811660

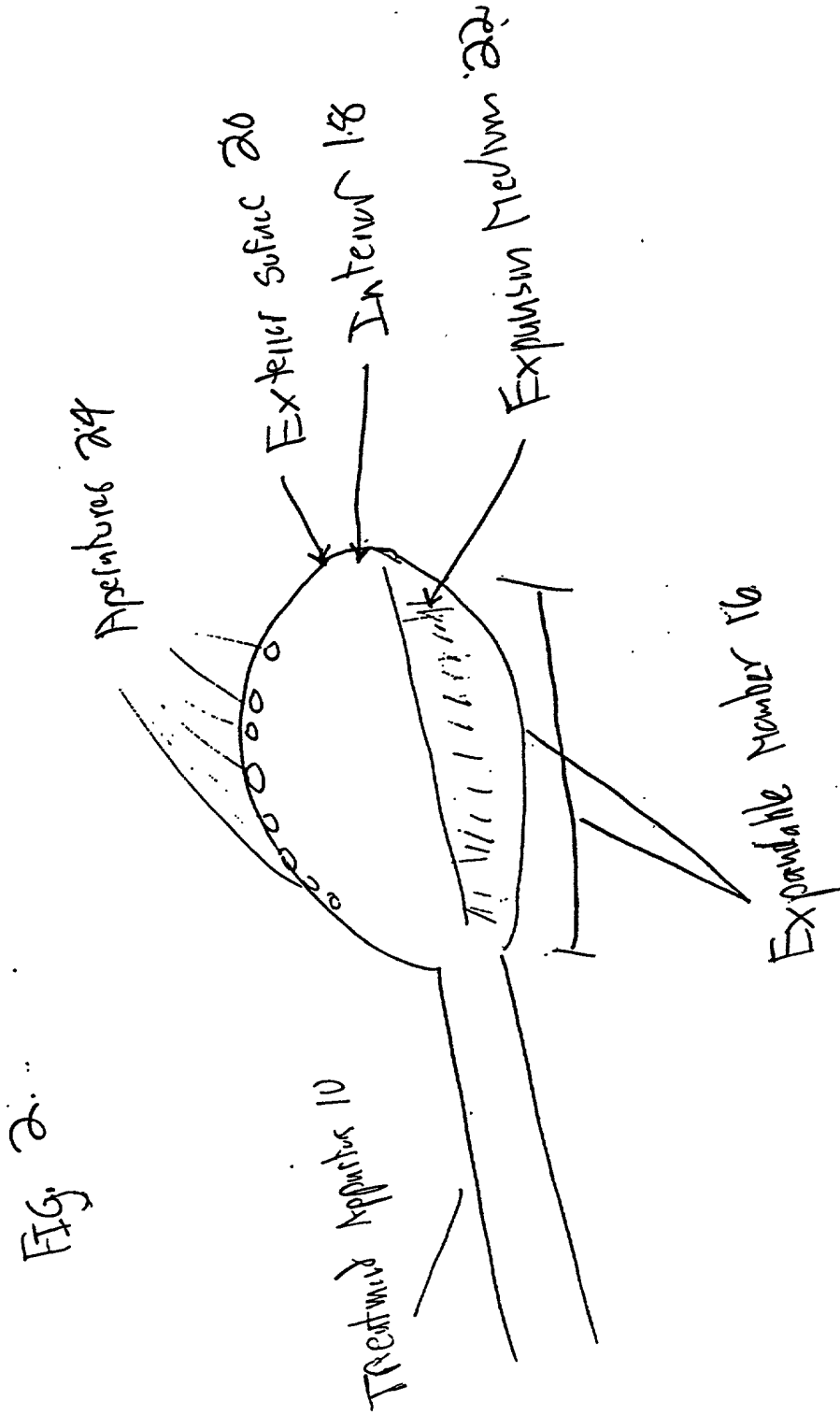

Fig. 2.

FIG. 3

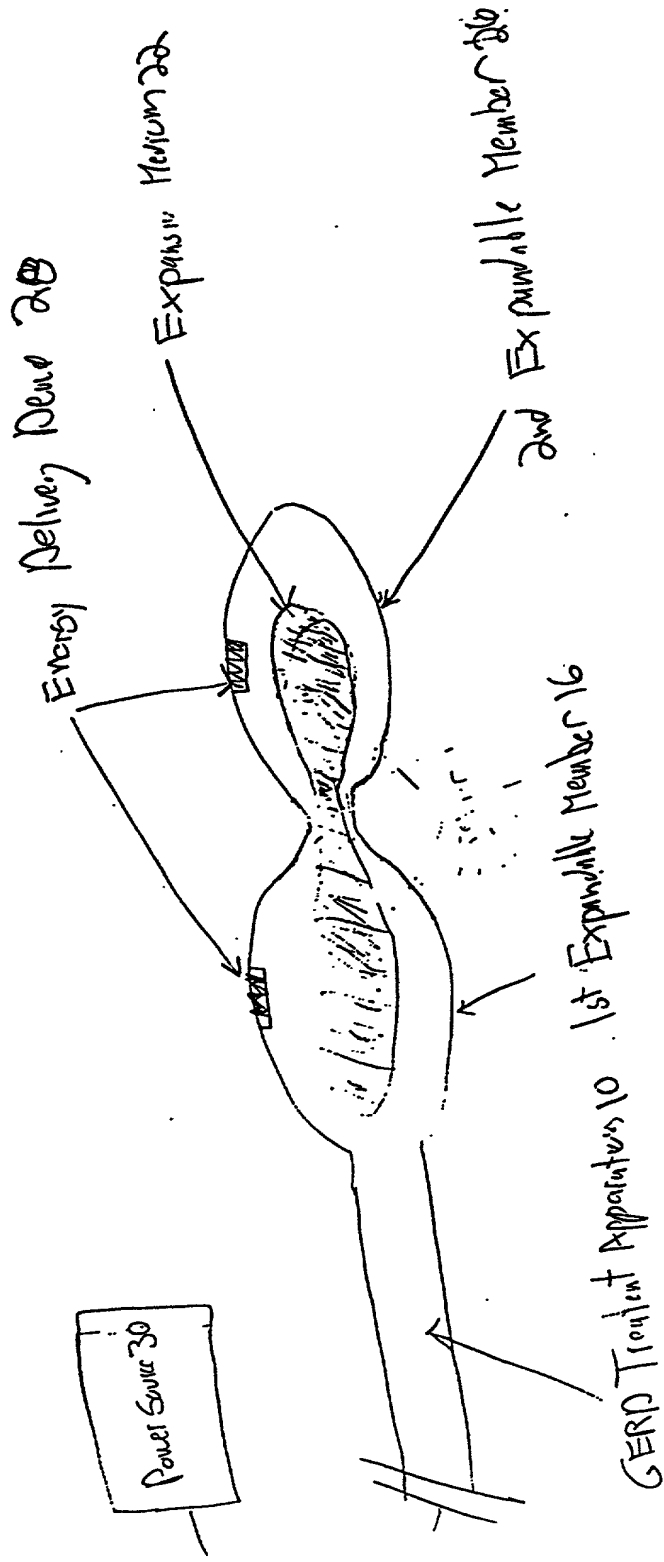

FIG. 4

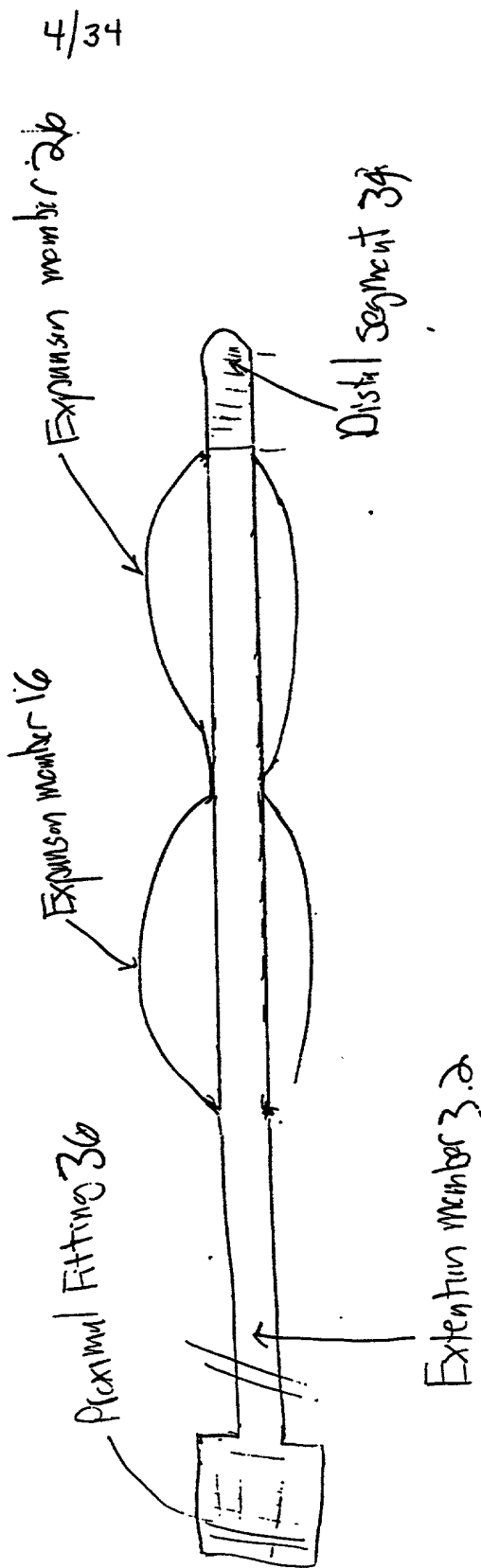



FIG. 5

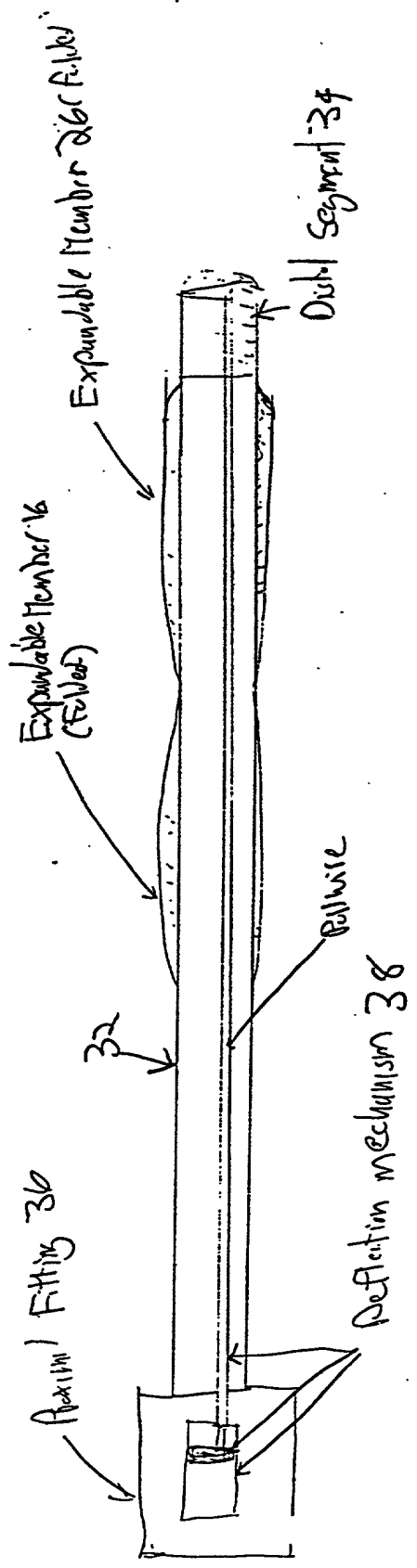

FIG. 6A

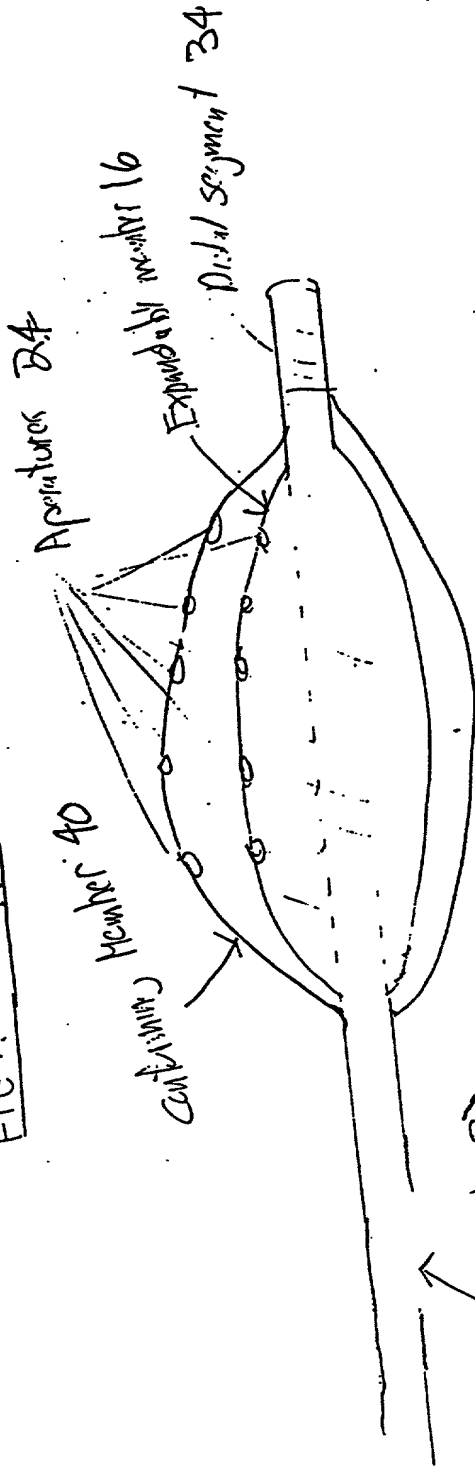
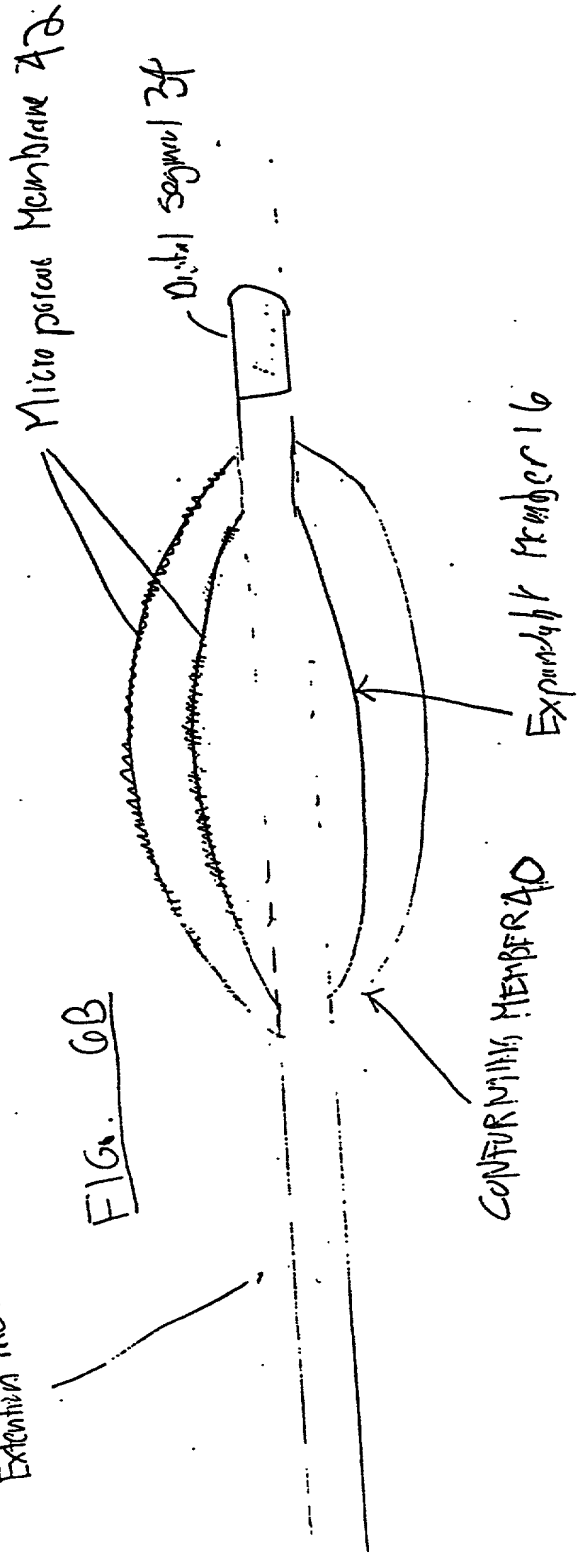

FIG. 6B



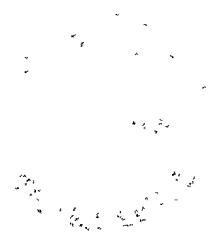
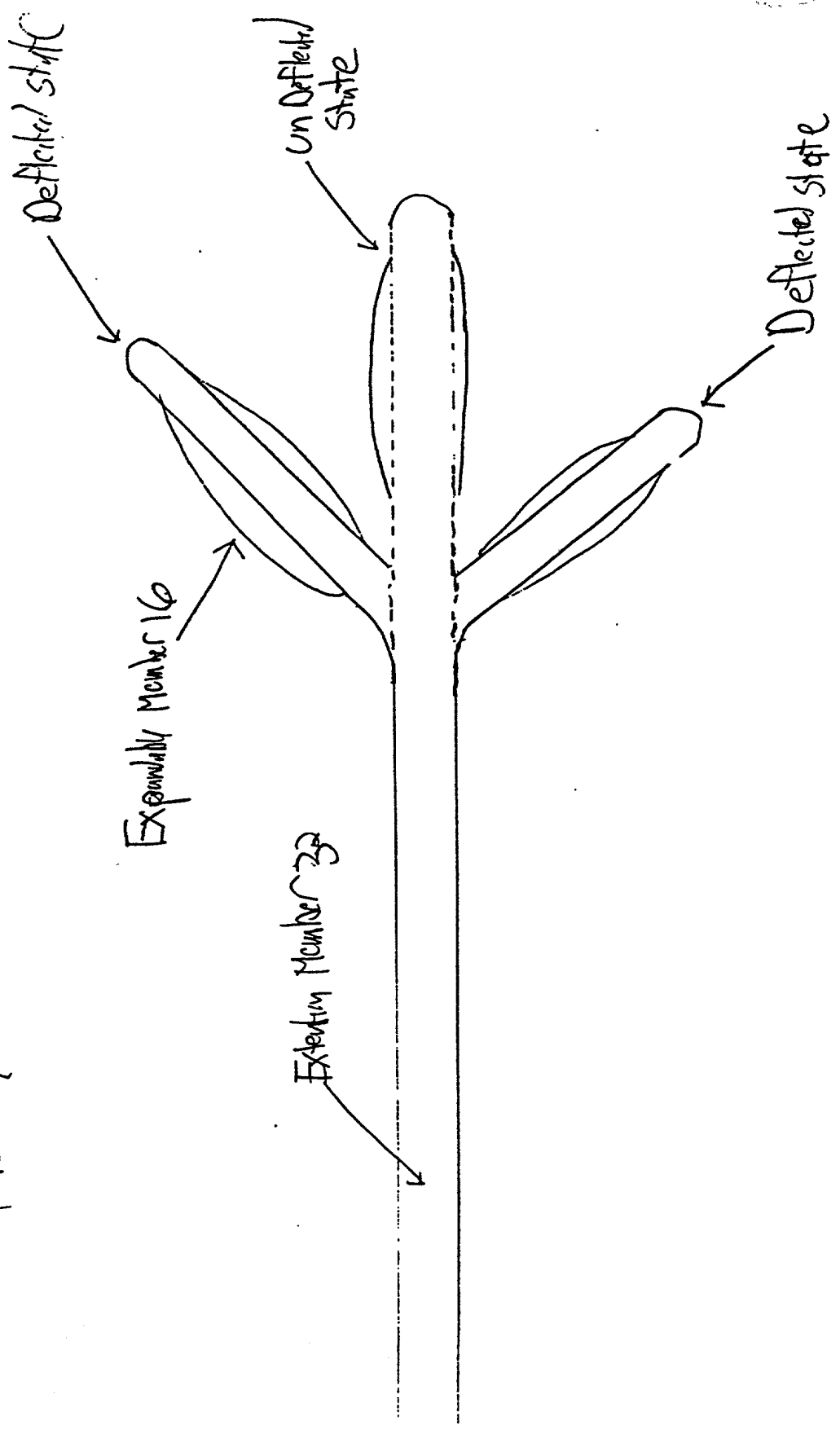

FIG. 7



20000481650

8/34

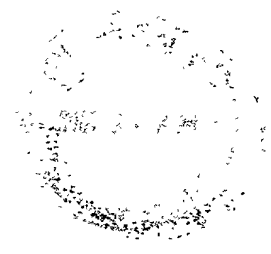
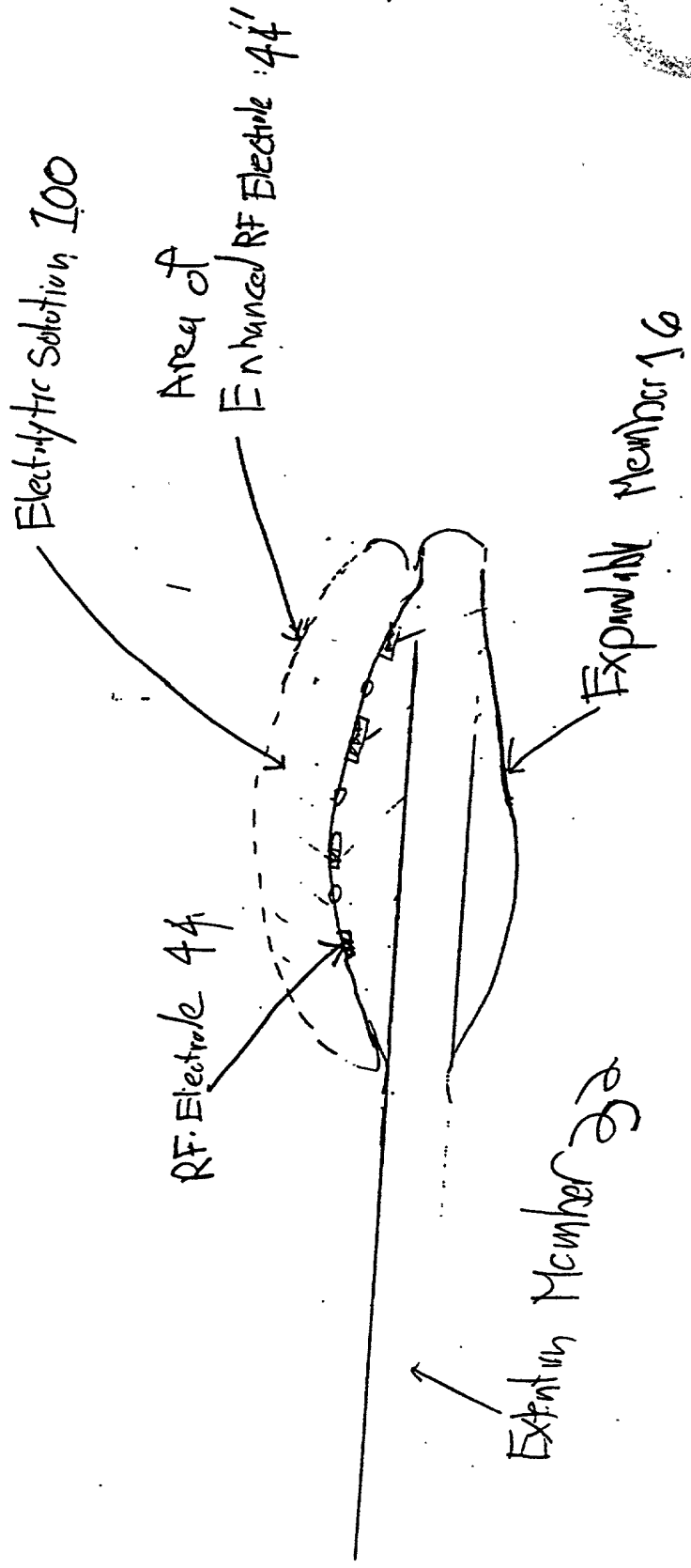

FIG. 8.



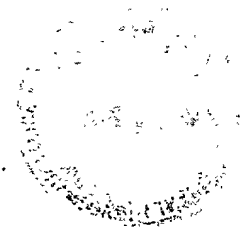

FIG. 9A Radial Electrode Pattern.

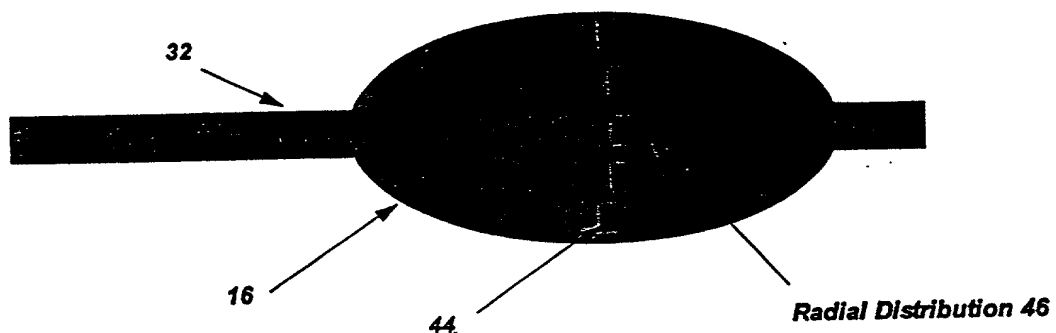

FIG. 9B Longitudinal Electrode Pattern.

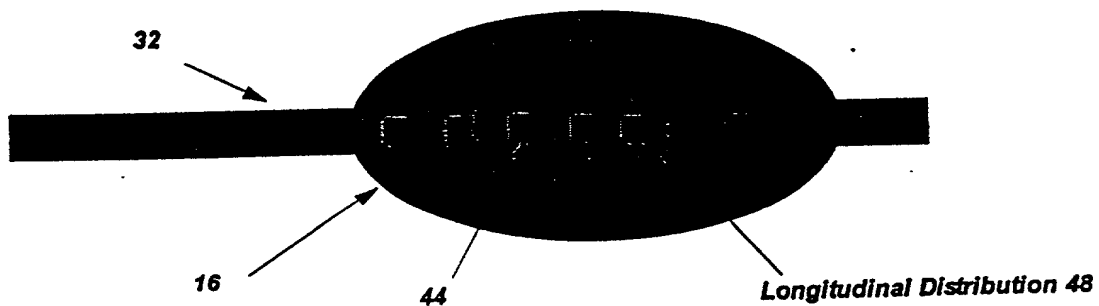
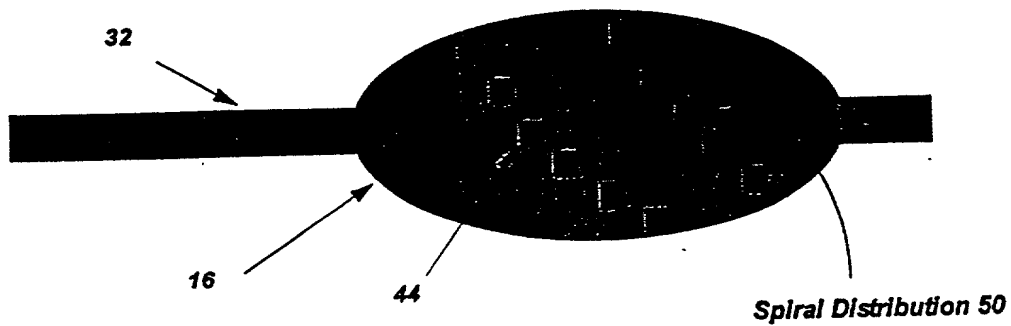

FIG. 9C Spiral Electrode Pattern.



2002E04416B0

10/34



FIG. 10

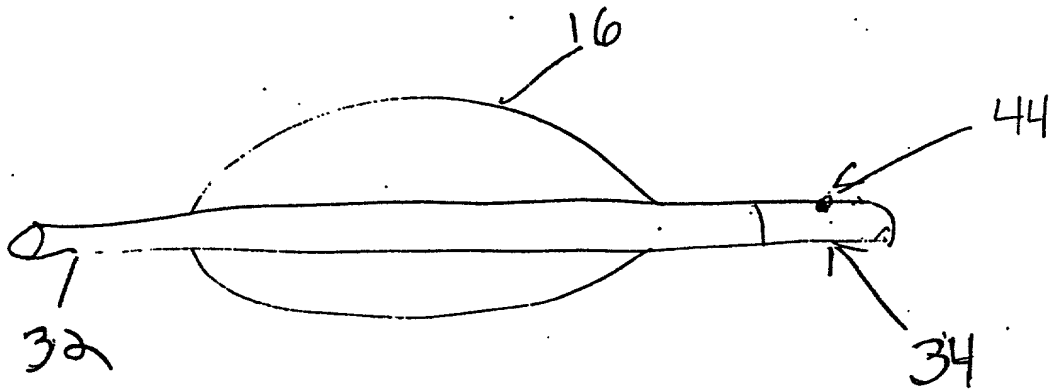

2002004231660

11/34

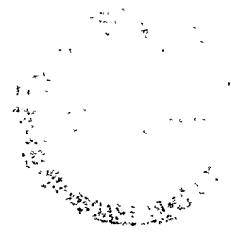
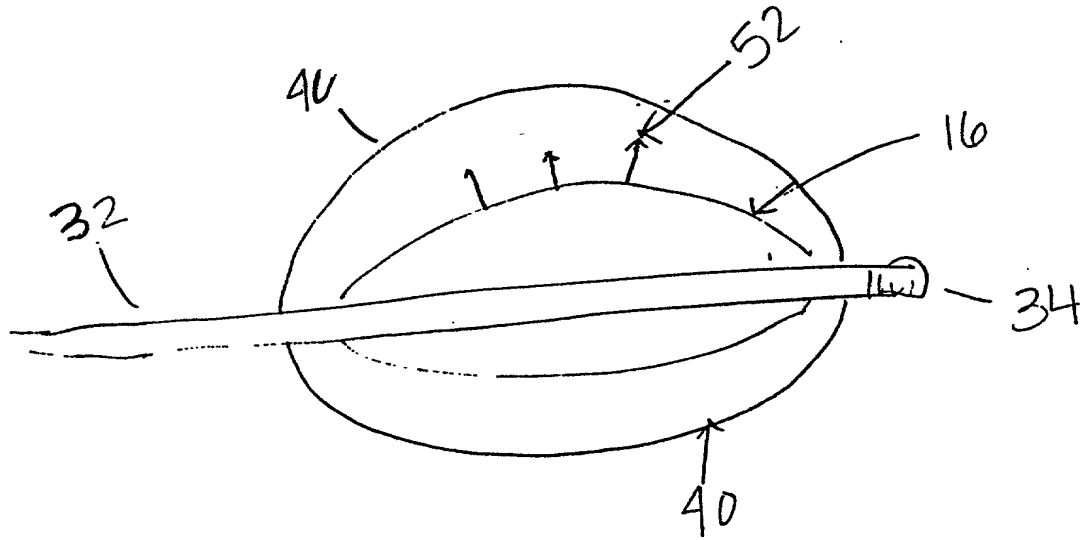

FIG. 11



200260-42811650

12/34

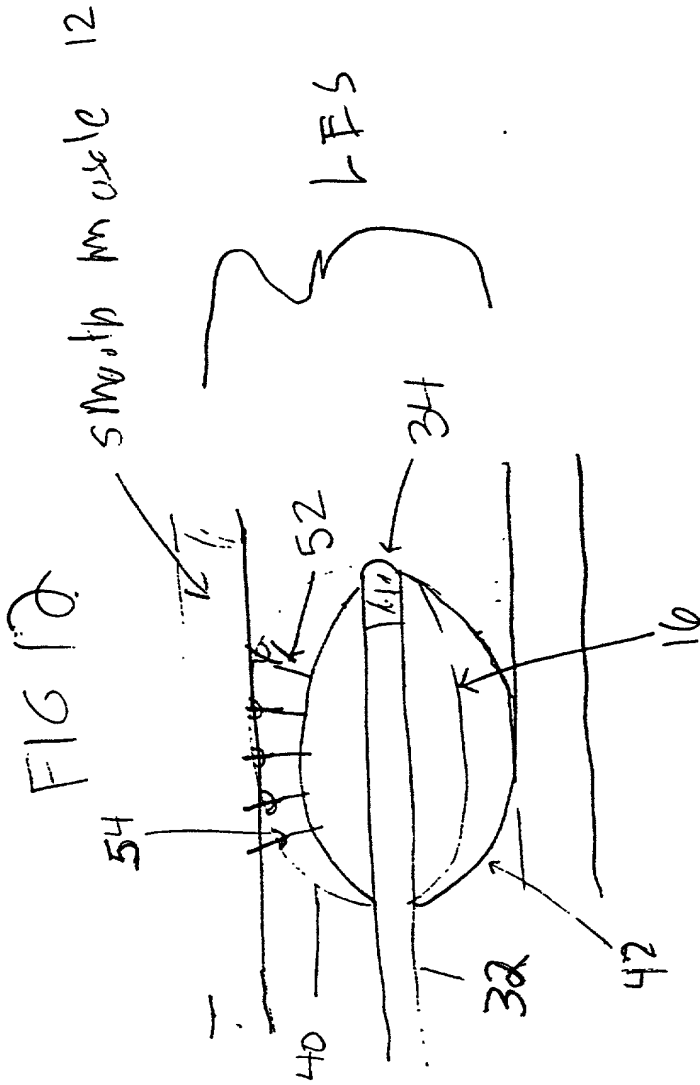
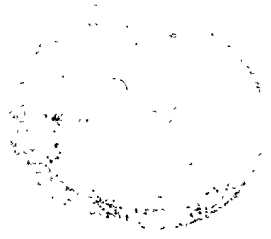
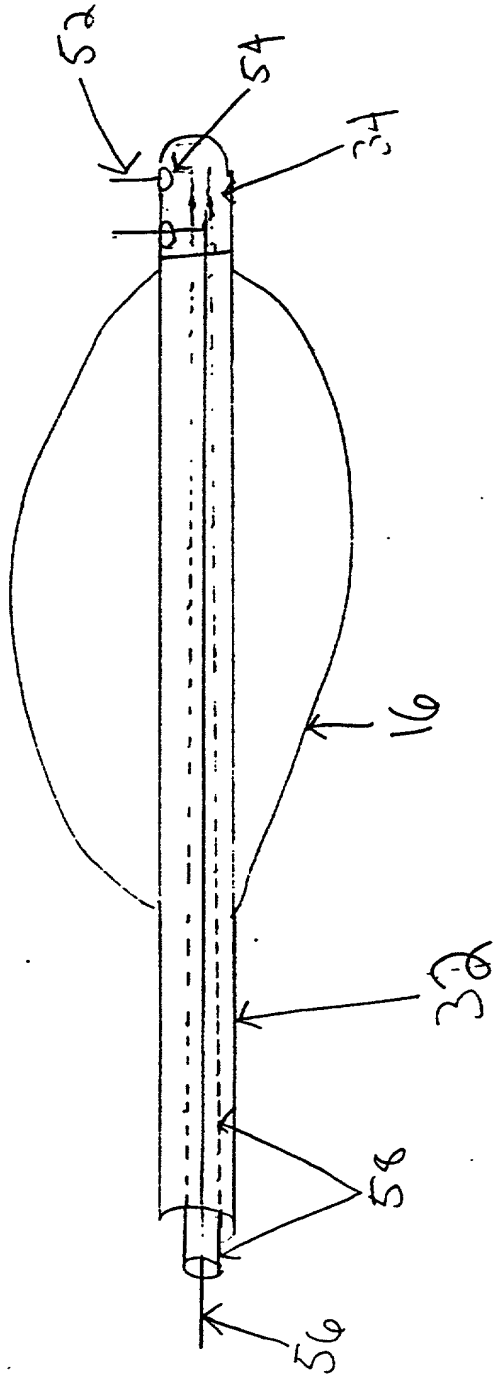



FIG. 13



20020714B11650

FIG. 14

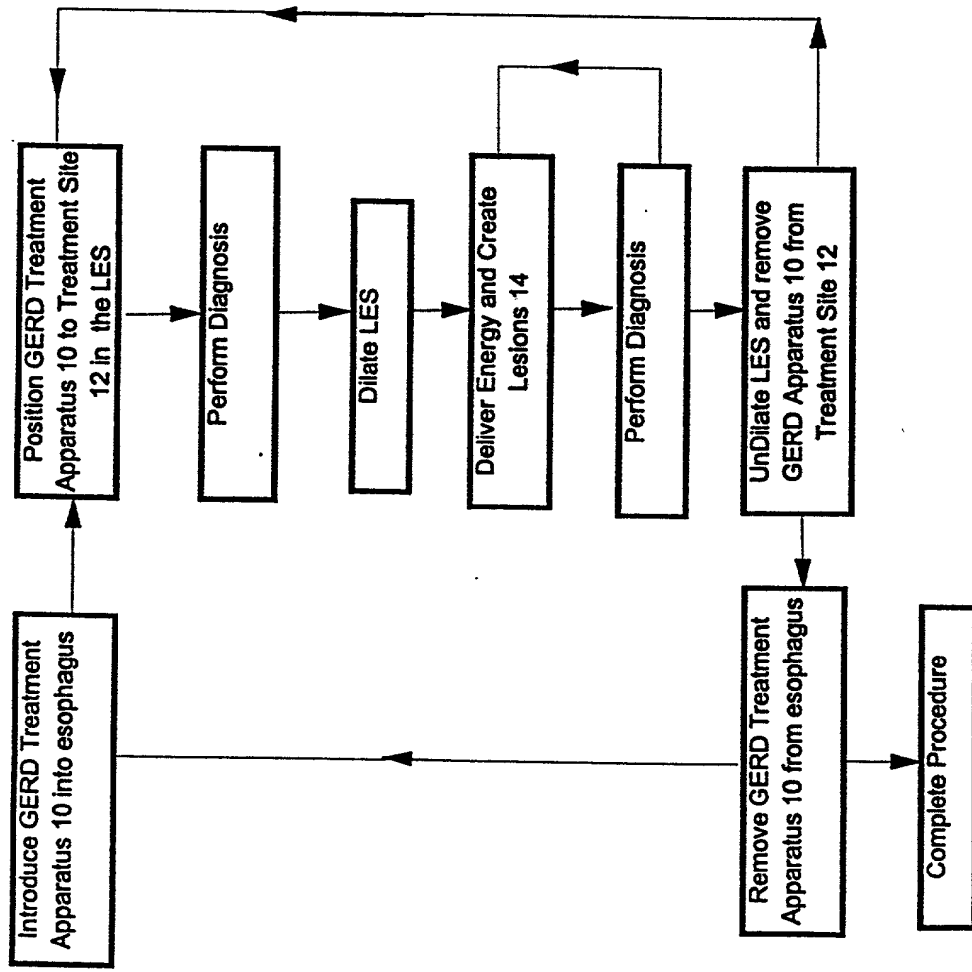
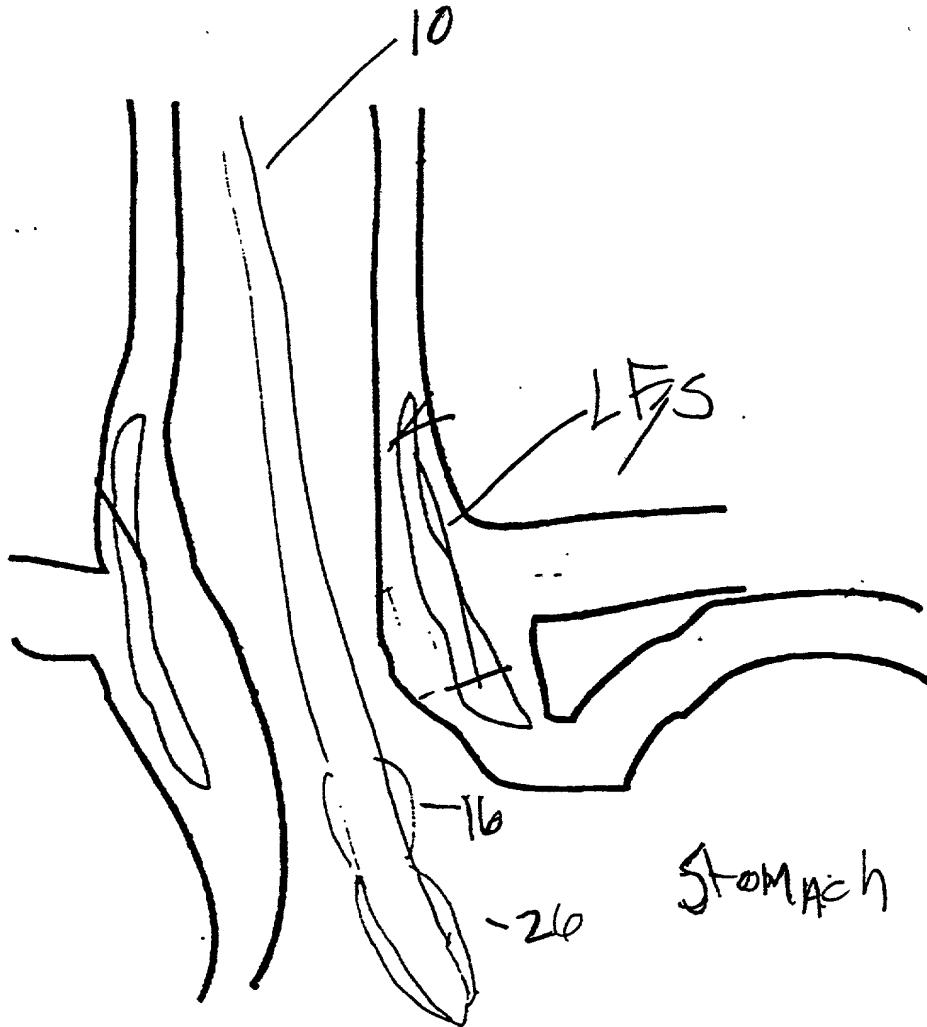

FIG. = 15A

15/34



200250-42811660

16/34

FIG. 15 B

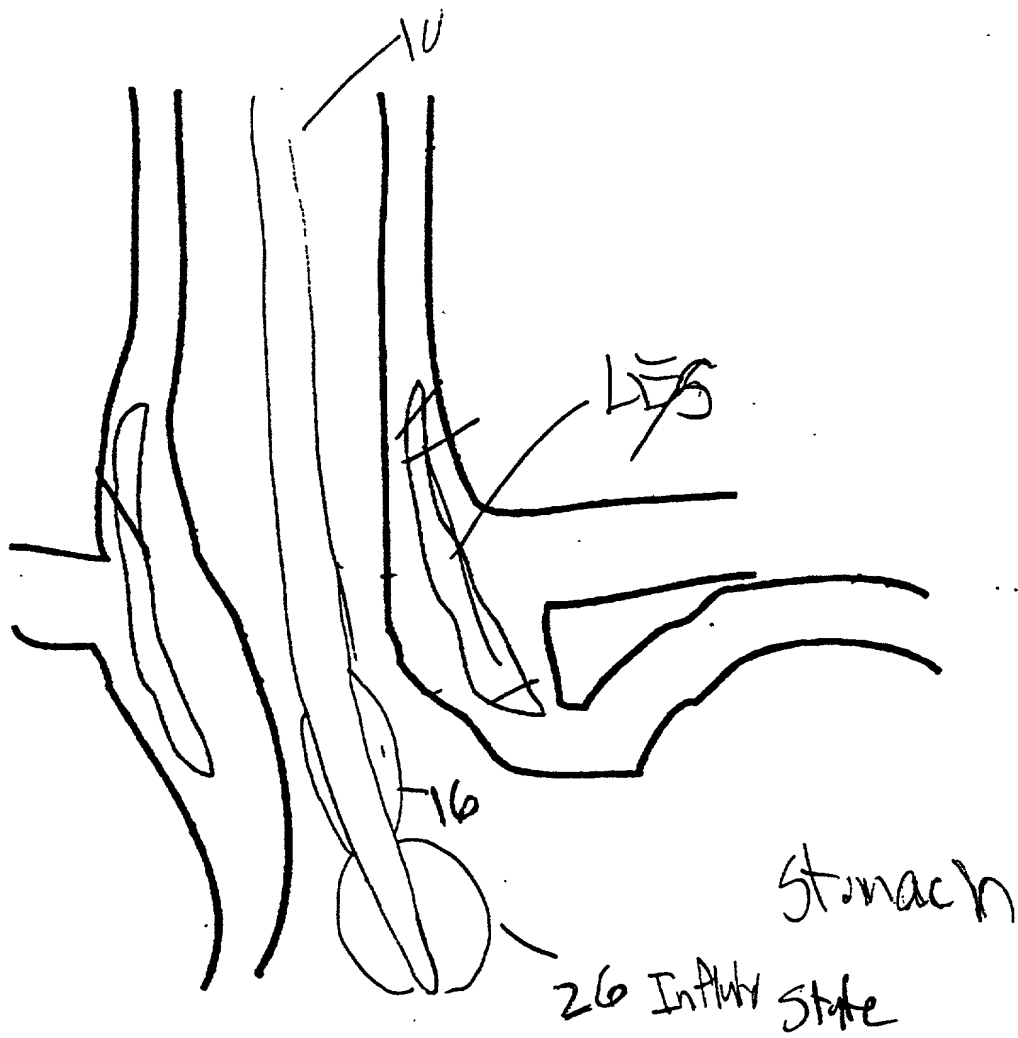

20250421650

FIG 15C

17/34

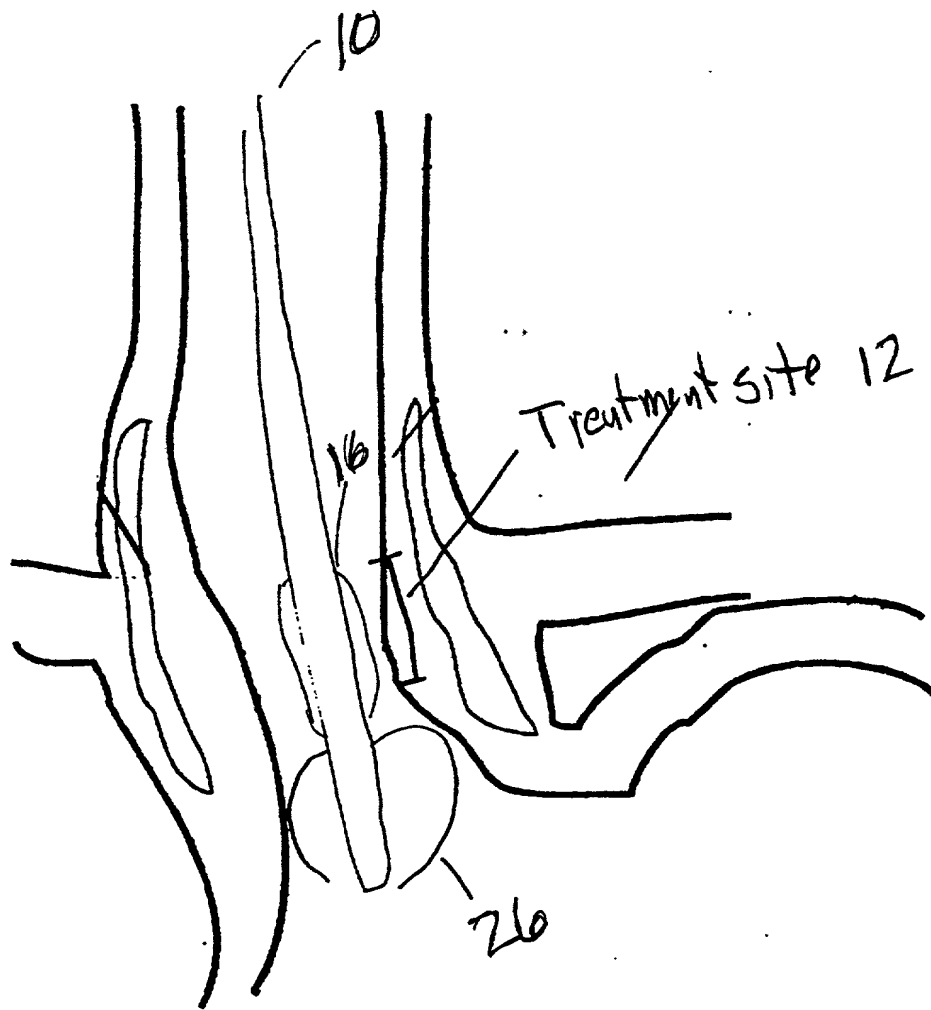

090220-44871650



Fig 16

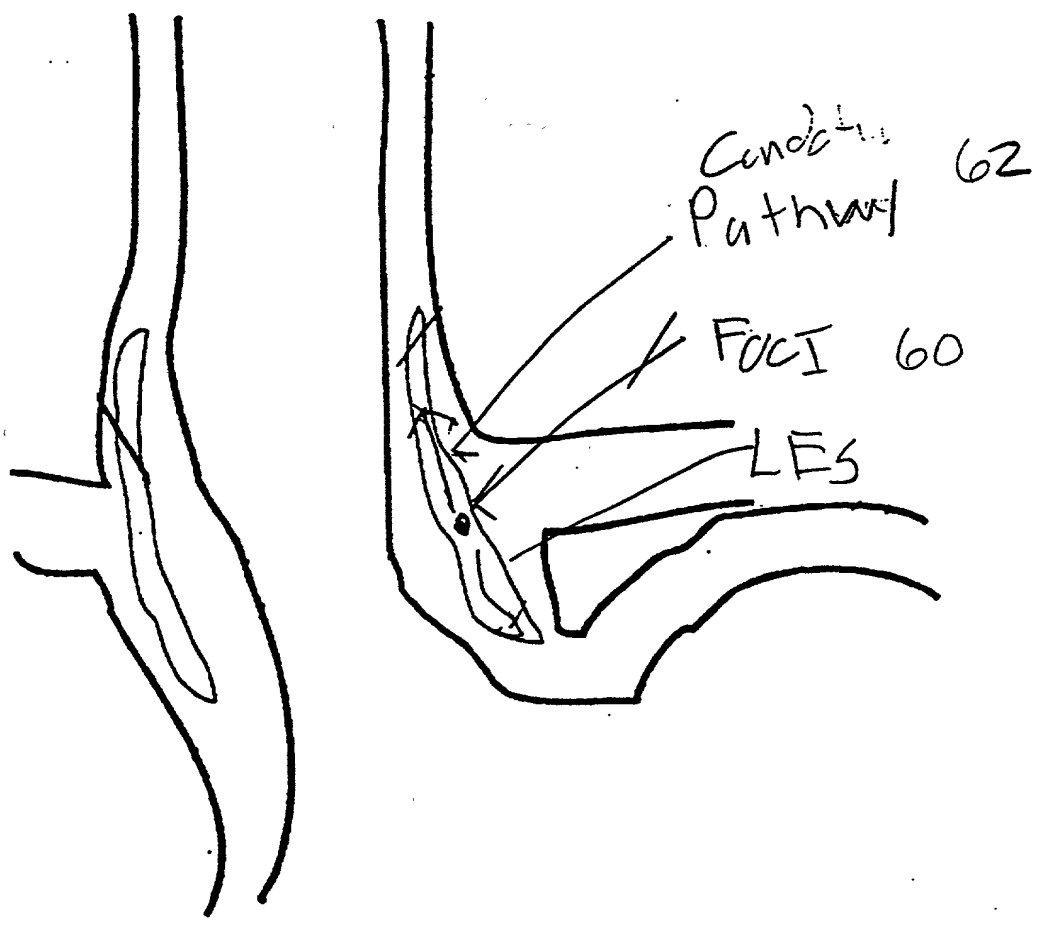

20250428T1650

19/34

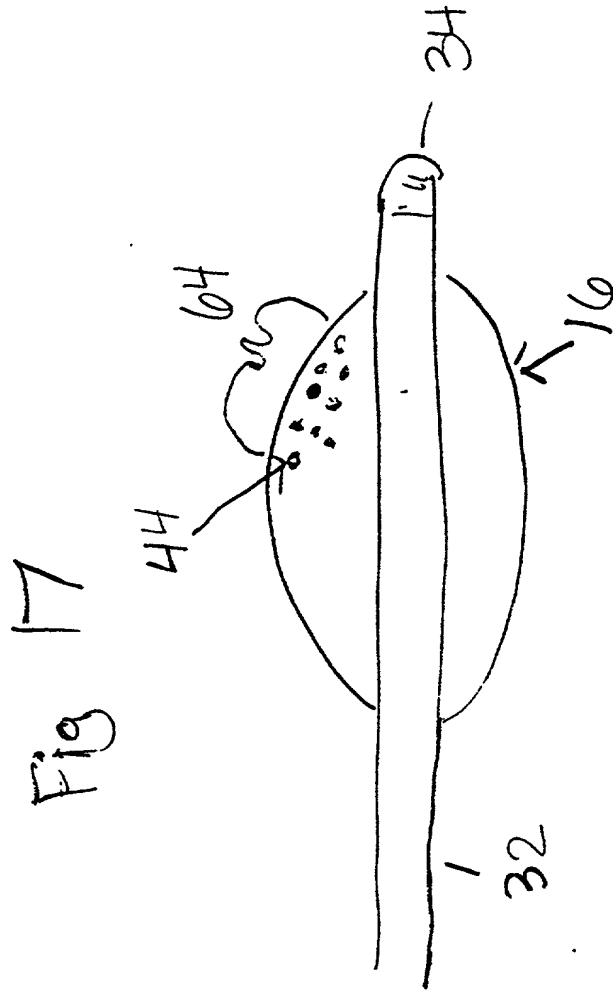
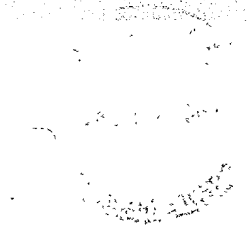
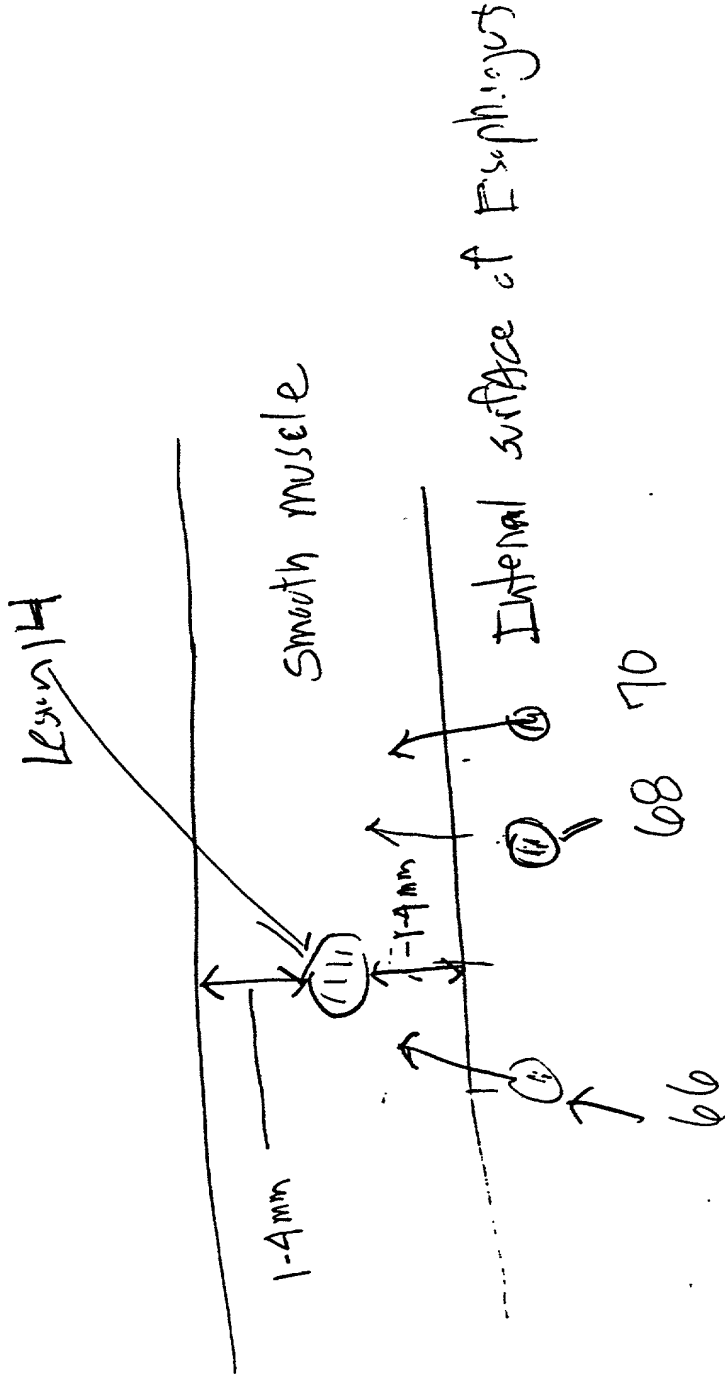

Fig 17



20/34

FIG 16



00020-42811660

FIG 19A

LES Smooth Muscle

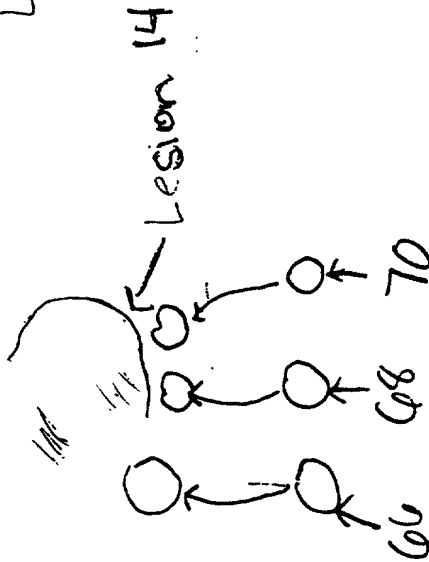

21/34



2002E0-4287F560

22/34

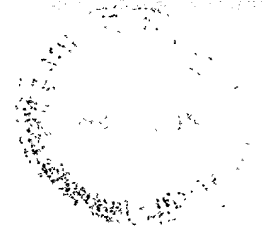
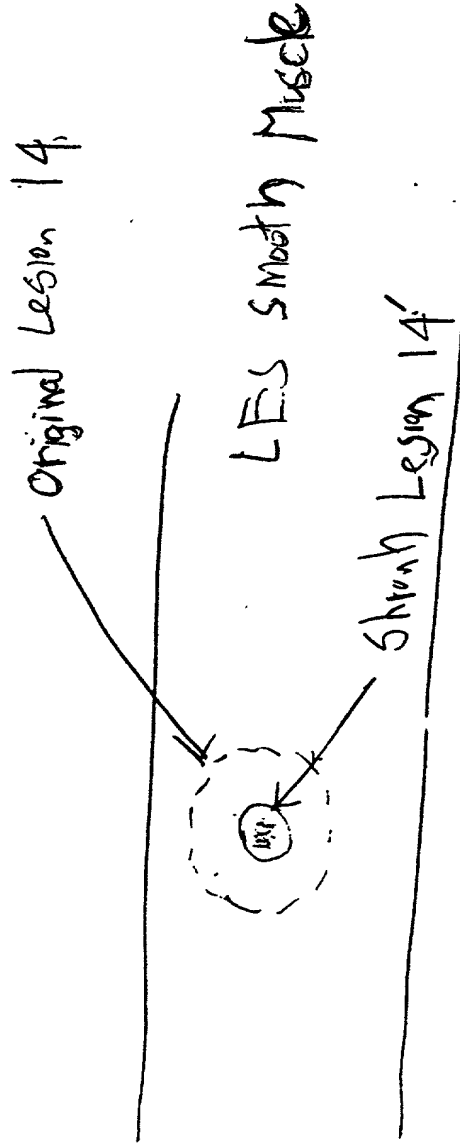

FIG. 19B



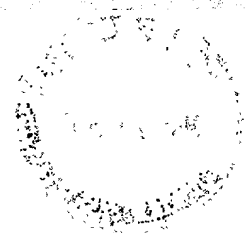
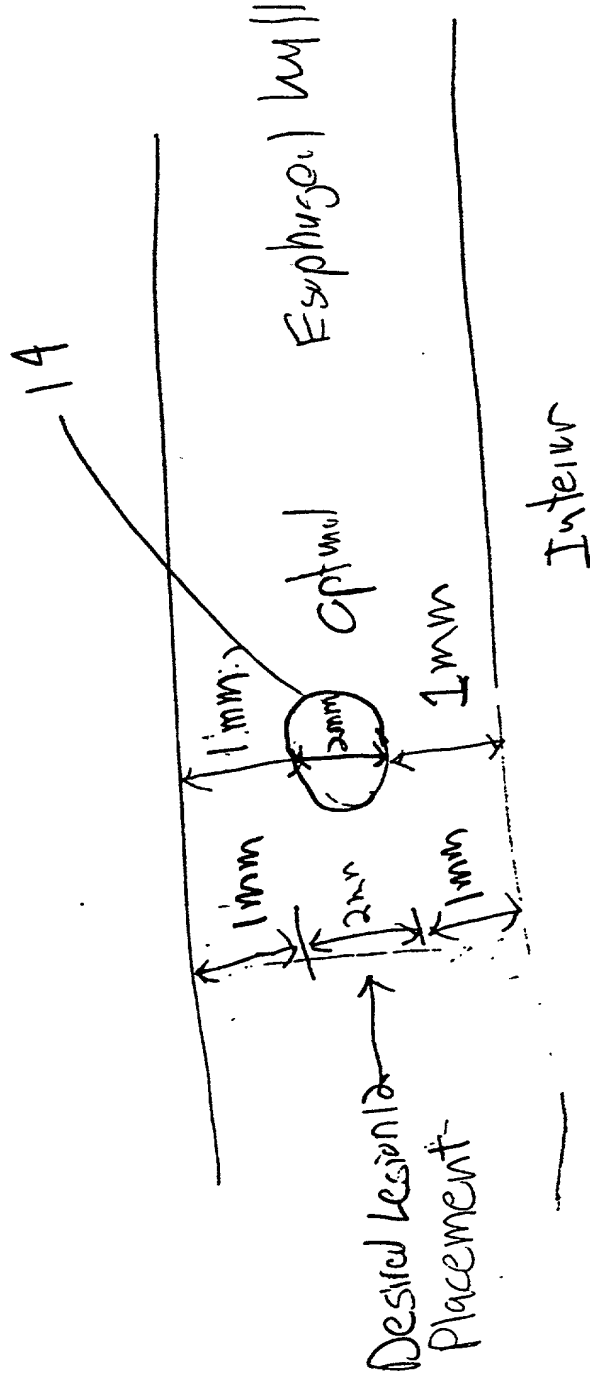

Fig. 20



200250-142811650

24/34

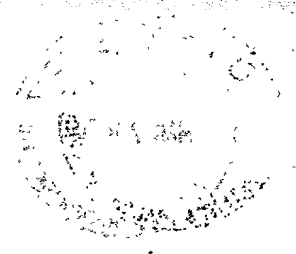
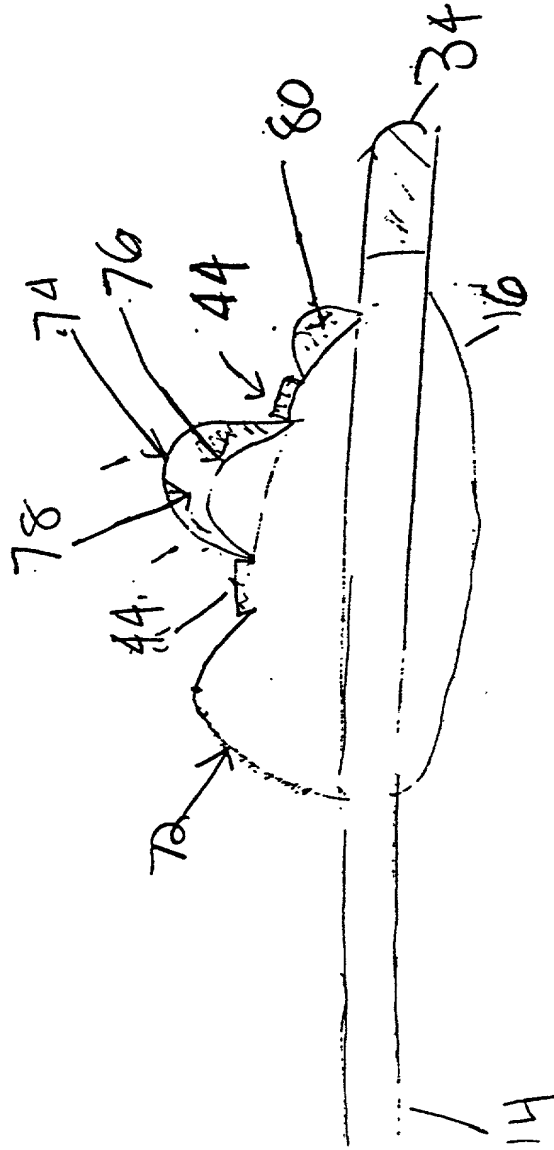

FIG. 21





2025071600

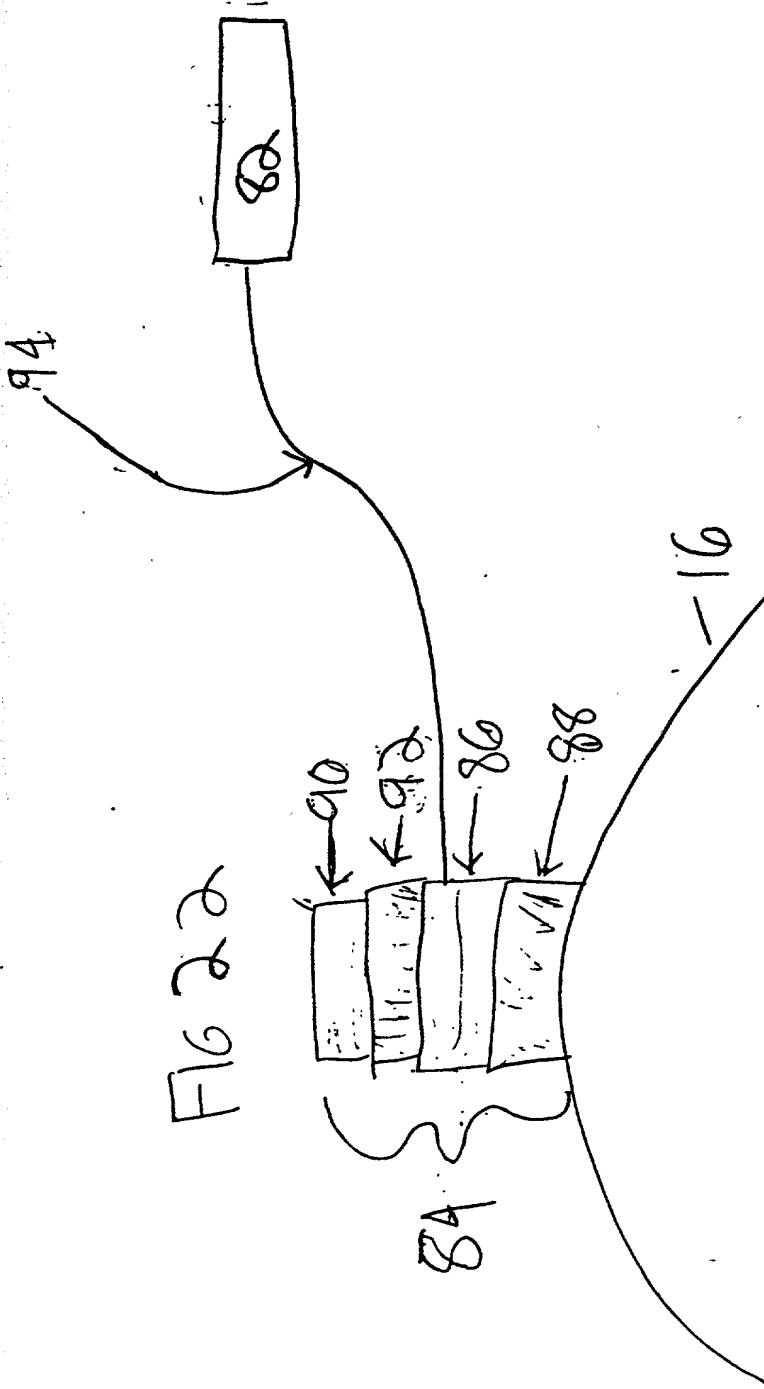

FIG 22



200004241650

FIG 23B

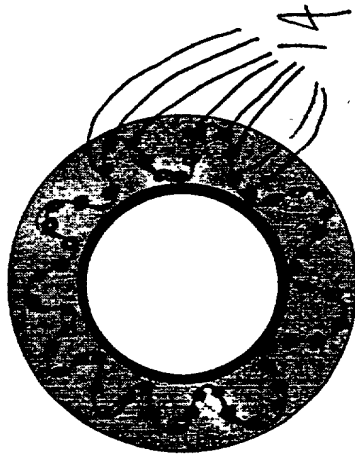

FIG 23D

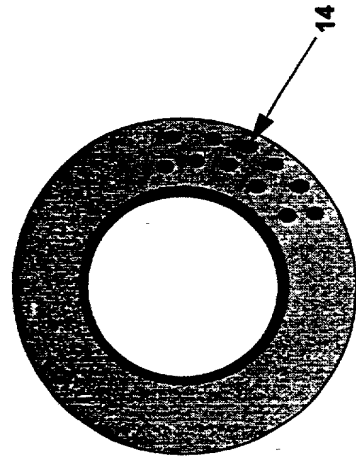

FIG 23A

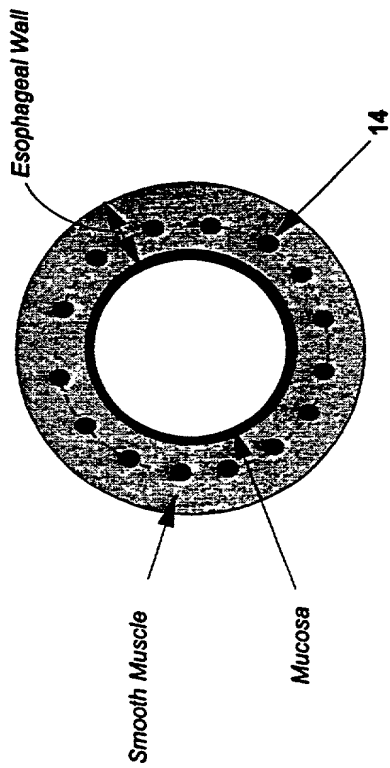
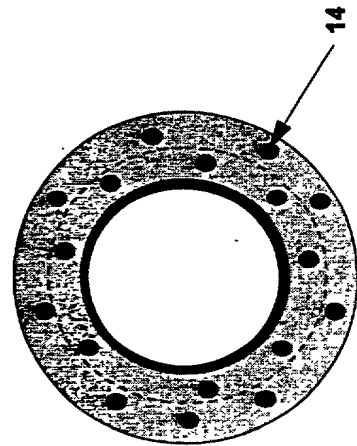

FIG 23C





202507140000

FIG 2A

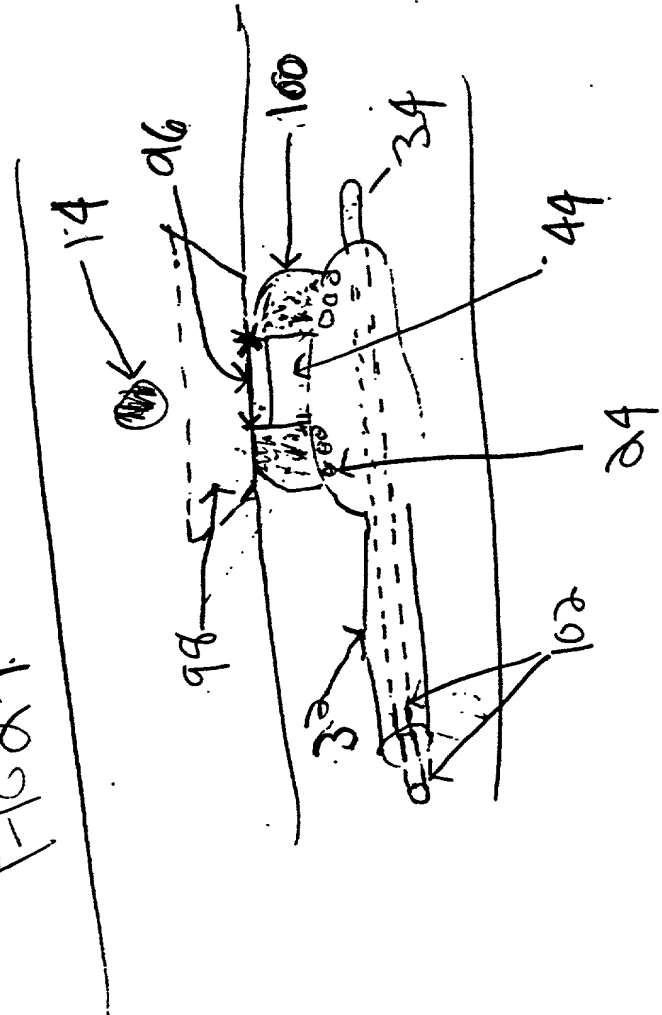

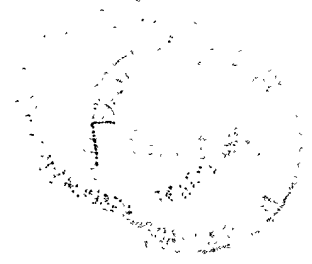

20250414BTT600

FIG. 25

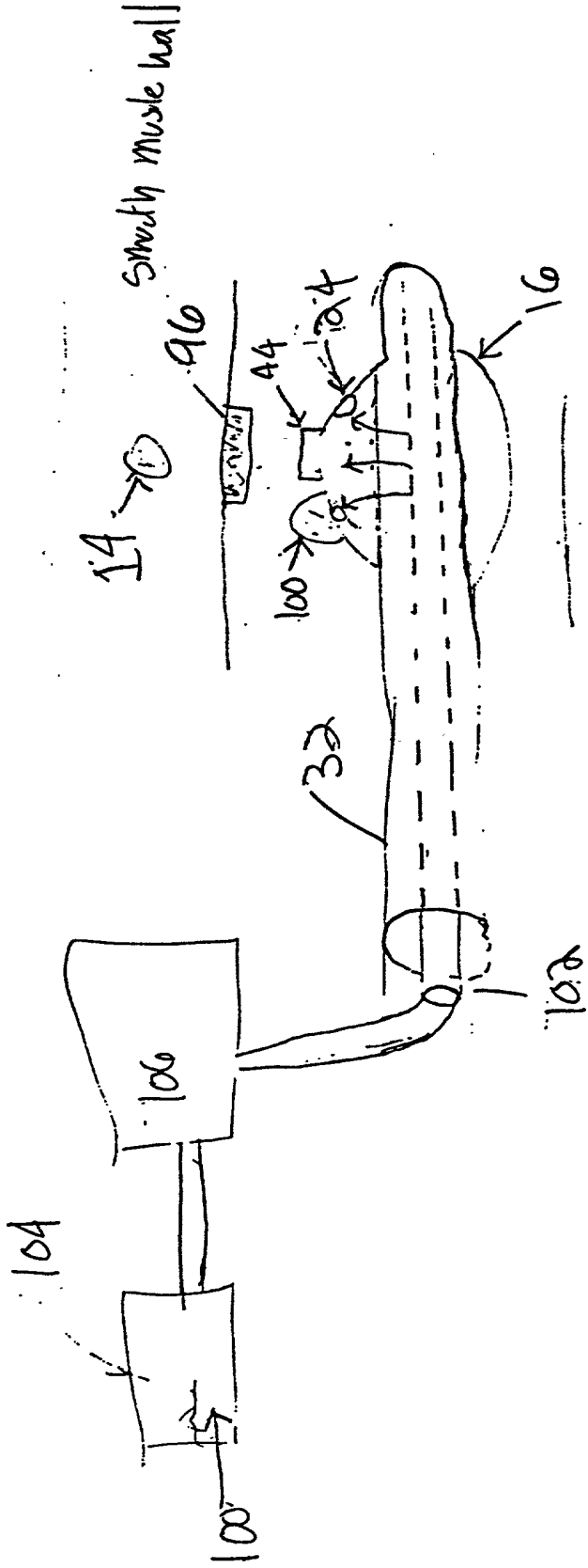

29/34



20250416160

FIG. 26

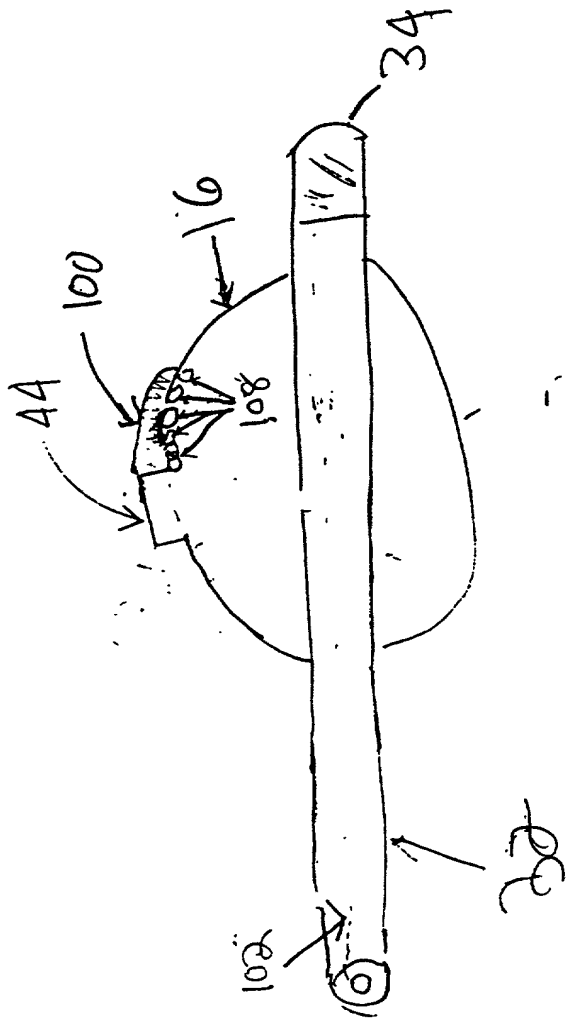
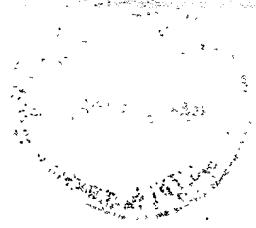
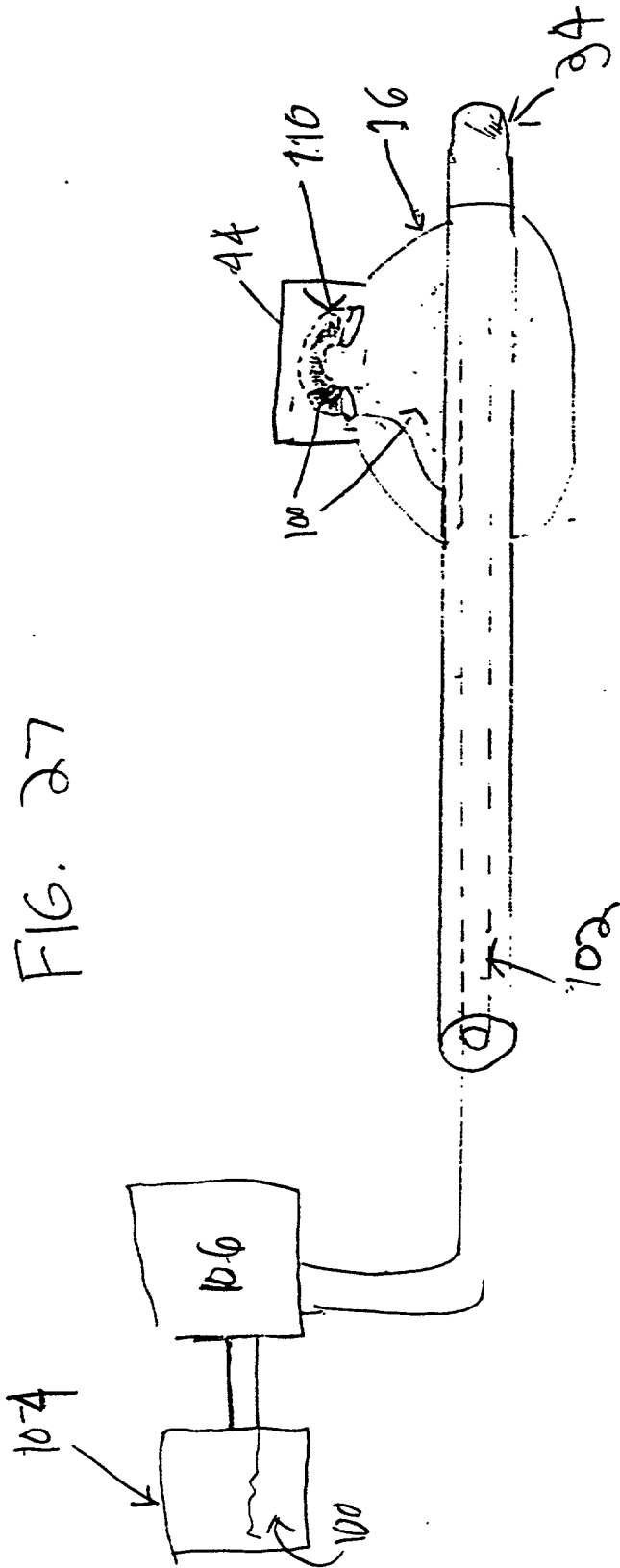
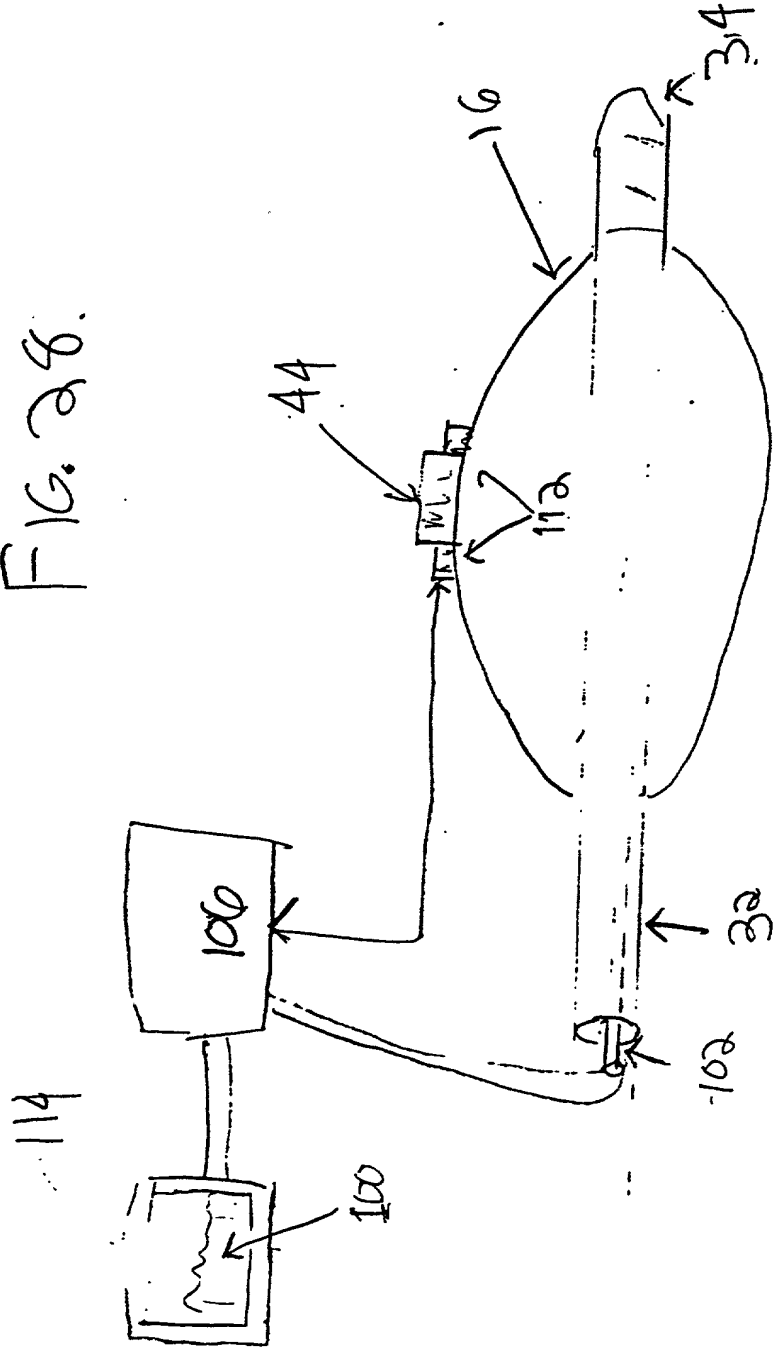

FIG. 27



200202742811660

FIG. 28.



200201231650

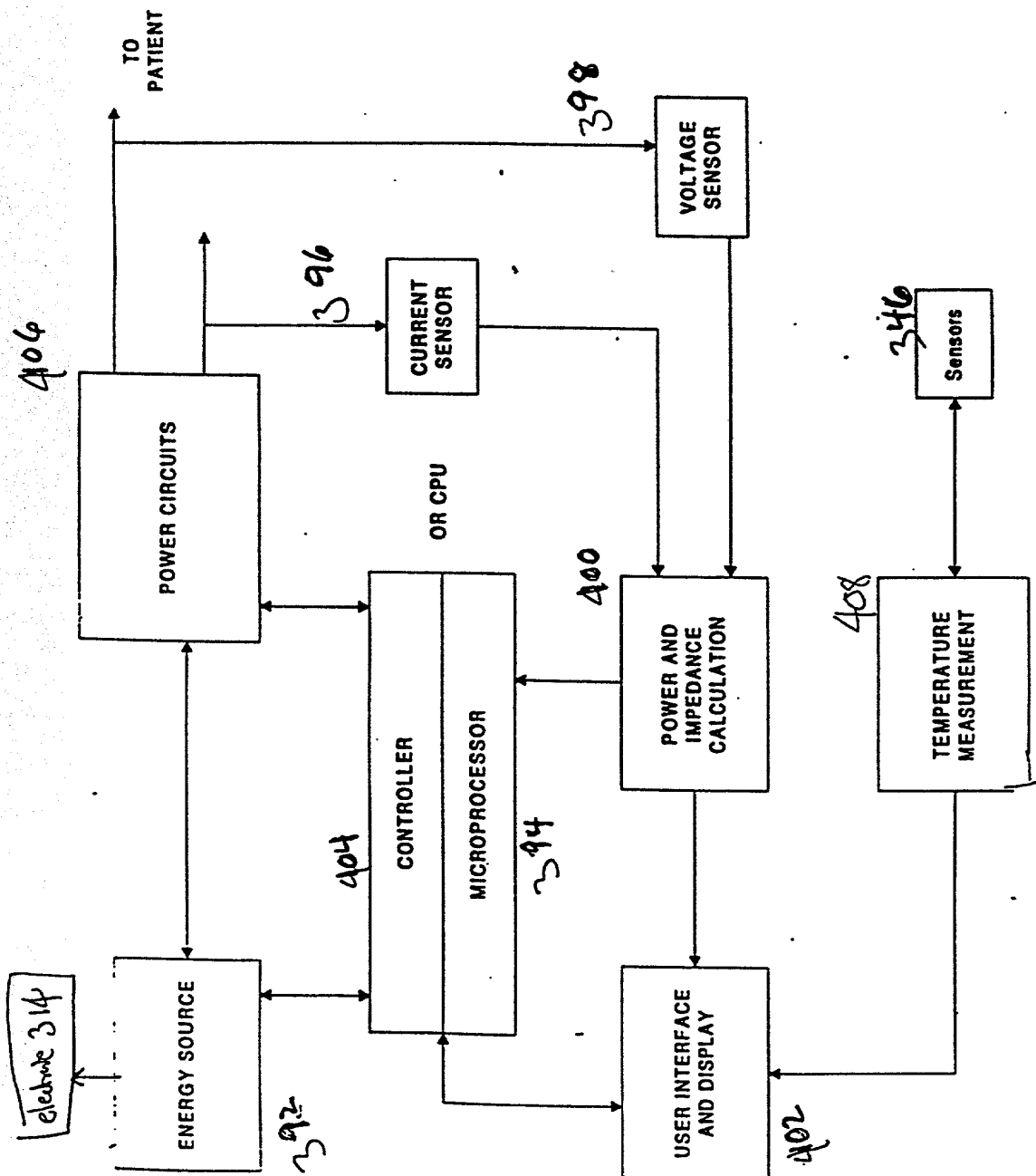

FIGURE 29

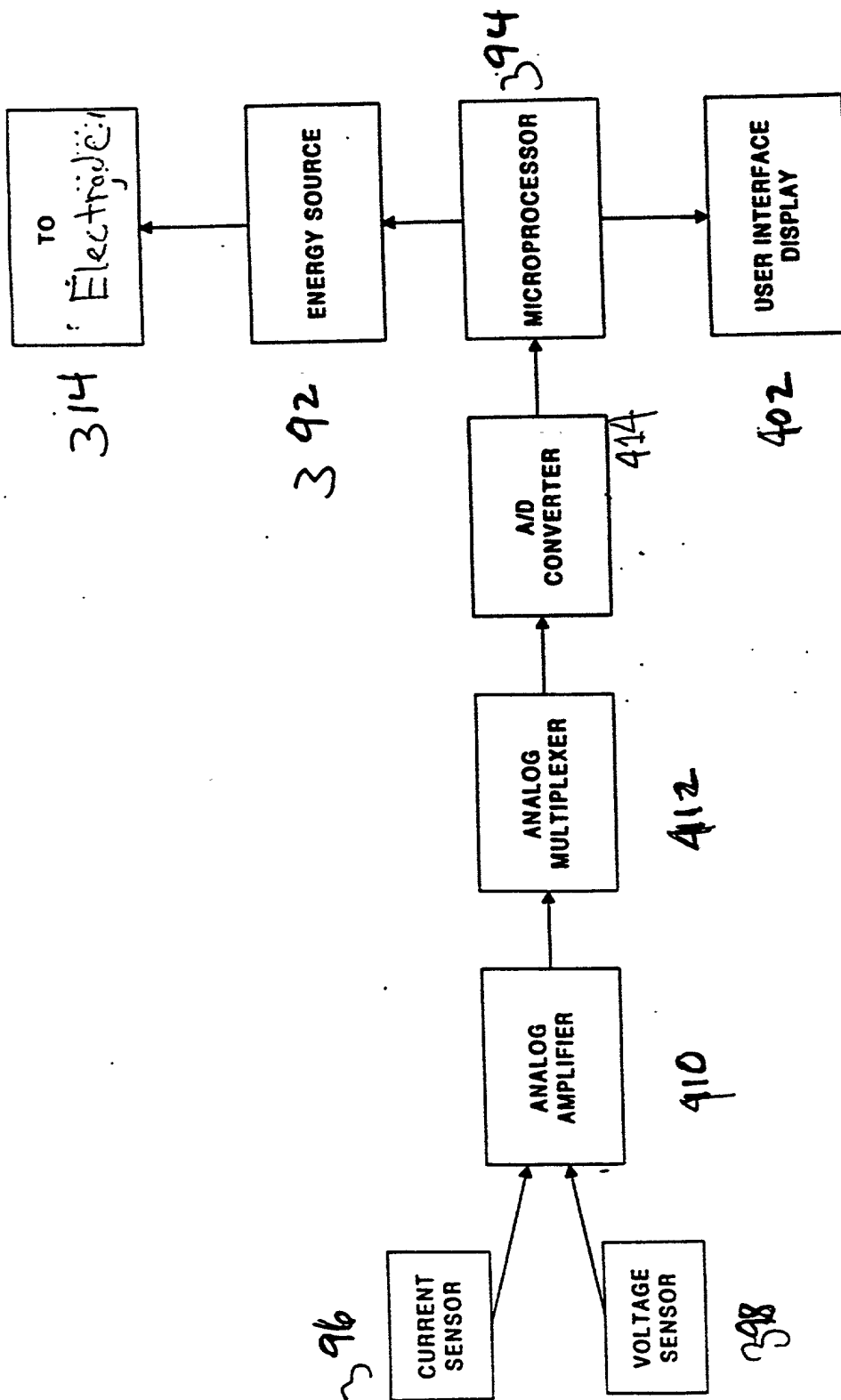

FIGURE 30

200250-4-81-1650

420

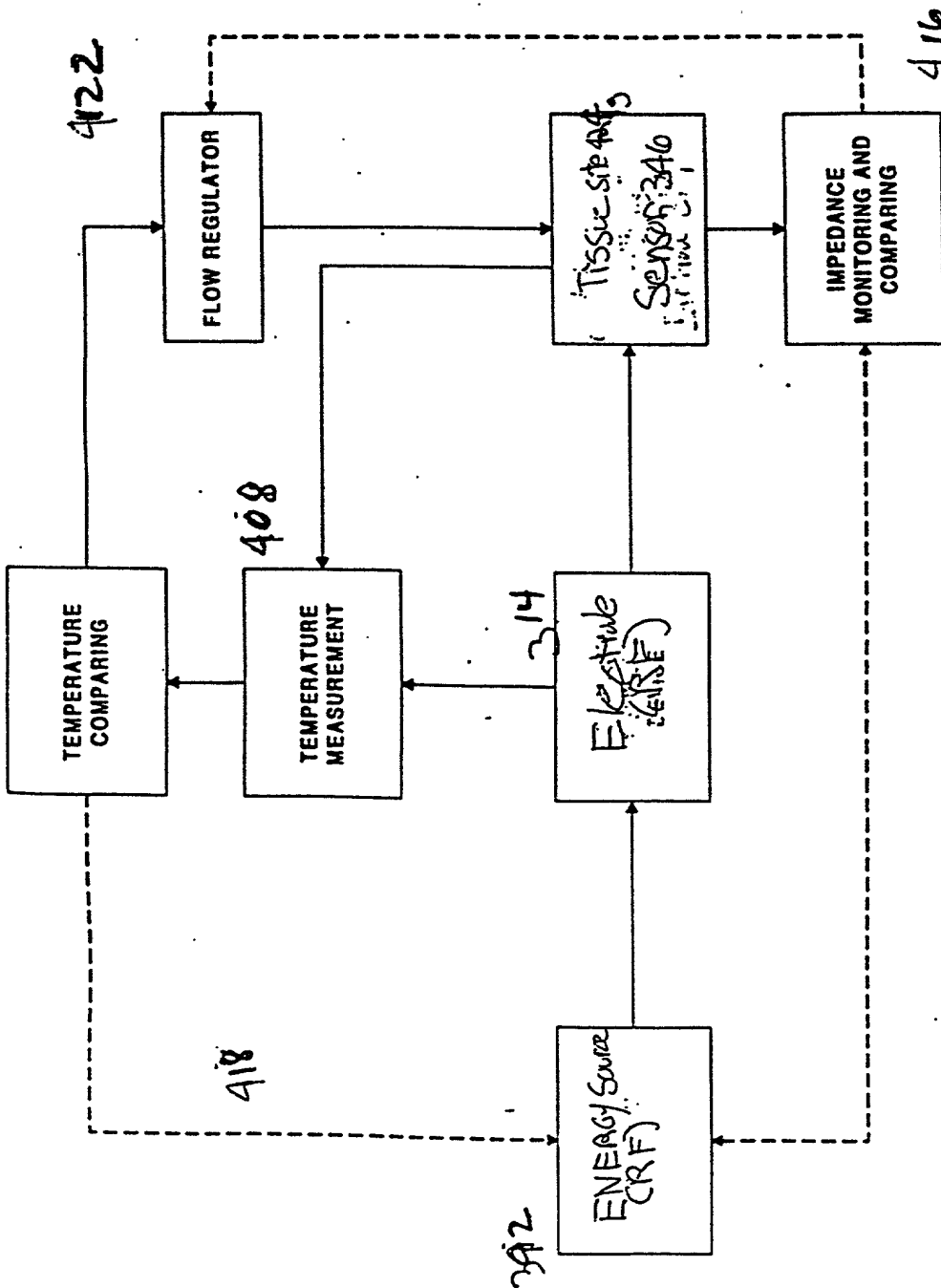

FIGURE 31

200004281660